



ELSEVIER

Physica A 281 (2000) 173–200

PHYSICA A

www.elsevier.com/locate/physa

Knot theory and the heuristics of functional integration

Louis H. Kauffman*

*Department of Mathematics, Statistics and Computer Science, University of Illinois at Chicago,
851 South Morgan Street, Chicago, IL 60607-7045, USA*

Abstract

This paper is an exposition of the relationship between the heuristics of Witten's functional integral and the theory of knots and links in three-dimensional space. © 2000 Elsevier Science B.V. All rights reserved.

1. Introduction

This paper shows how the Kontsevich integrals, giving Vassiliev invariants in knot theory, arise naturally in the perturbative expansion of Witten's functional integral. The relationship between Vassiliev invariants and Witten's integral has been known since Bar-Natan's thesis [1] where he discovered, through this connection, how to define Lie algebraic weight systems for these invariants.

The paper is a sequel to Ref. [2]. See also the work of Labastida and Pérez [3] on this same subject. Their work comes to an identical conclusion, interpreting the Kontsevich integrals in terms of the light-cone gauge and thereby extending the original work of Fröhlich and King [4]. The purpose of this paper is to give an exposition of these relationships and to introduce diagrammatic techniques that illuminate the connections. In particular, we use a diagrammatic operator method that is useful both for Vassiliev invariants and for relations of this subject with the quantum gravity formalism of Ashtekar et al. [5]. This paper also treats the perturbation expansion via three-space integrals leading to Vassiliev invariants as in Refs. [1,6], see also Ref. [7]. We do not deal with the combinatorial reformulation of Vassiliev invariants that proceeds from the Kontsevich integrals as in Ref. [8].

* Fax: +1-312 996 1491.

E-mail address: kauffman@uic.edu (L.H. Kauffman)

The paper is divided into five sections. Section 2 discusses Vassiliev invariants and invariants of rigid vertex graphs. Section 3 introduces the basic formalism and shows how the functional integral is related directly to Vassiliev invariants. In this section we also show how our formalism works for the loop transform of Ashtekar, Smolin and Rovelli. Section 4 discusses, without gauge fixing, the integral heuristics for the three-dimensional perturbative expansion. Section 5 shows how the Kontsevich integral arises in the perturbative expansion of Witten's integral in the light-cone gauge. One feature of Section 5 is a new and simplified calculation of the necessary correlation functions by using complex numbers and the two-dimensional Laplacian. We show how the Kontsevich integrals are the Feynman integrals for this theory. In a final section we discuss some of the possibilities of justifying functional integration on formal grounds.

2. Vassiliev invariants and invariants of rigid vertex graphs

If $V(K)$ is a (Laurent polynomial-valued, or more generally commutative ring-valued) invariant of knots, then it can be naturally extended to an invariant of rigid vertex graphs [9] by defining the invariant of graphs in terms of the knot invariant via an “unfolding” of the vertex. That is, we can regard the vertex as a “black box” and replace it by any tangle of our choice. Rigid vertex motions of the graph preserve the contents of the black box, and hence implicate ambient isotopies of the link obtained by replacing the black box by its contents. Invariants of knots and links that are evaluated on these replacements are then automatically rigid vertex invariants of the corresponding graphs. If we set up a collection of multiple replacements at the vertices with standard conventions for the insertions of the tangles, then a summation over all possible replacements can lead to a graph invariant with new coefficients corresponding to the different replacements. In this way each invariant of knots and links implicates a large collection of graph invariants; see Refs. [9,10].

The simplest tangle replacements for a 4-valent vertex are the two crossings, positive and negative, and the oriented smoothing. Let $V(K)$ be any invariant of knots and links. Extend V to the category of rigid vertex embeddings of 4-valent graphs by the formula

$$V(K_*) = aV(K_+) + bV(K_-) + cV(K_0),$$

where K_+ denotes a knot diagram K with a specific choice of positive crossing, K_- denotes a diagram identical to the first with the positive crossing replaced by a negative crossing and K_* denotes a diagram identical to the first with the positive crossing replaced by a graphical node.

This formula means that we define $V(G)$ for an embedded 4-valent graph G by taking the sum

$$V(G) = \sum_S a^{i_+(S)} b^{i_-(S)} c^{i_0(S)} V(S)$$

with the summation over all knots and links S obtained from G by replacing a node of G with either a crossing of positive or negative type, or with a smoothing of the

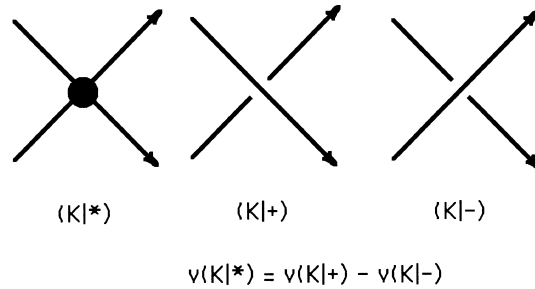

Fig. 1. Exchange identity for Vassiliev invariants.

crossing that replaces it by a planar embedding of non-touching segments (denoted 0). It is not hard to see that if $V(K)$ is an ambient isotopy invariant of knots, then, this extension is a rigid vertex isotopy invariant of graphs. In rigid vertex isotopy the cyclic order at the vertex is preserved, so that the vertex behaves like a rigid disk with flexible strings attached to it at specific points.

There is a rich class of graph invariants that can be studied in this manner. The Vassiliev invariants [11–13] constitute the important special case of these graph invariants where $a = +1$, $b = -1$ and $c = 0$. Thus $V(G)$ is a Vassiliev invariant if

$$V(K_*) = V(K_+) - V(K_-).$$

Call this formula the *exchange identity* for the Vassiliev invariant V . See Fig. 1. V is said to be of *finite type k* if $V(G) = 0$ whenever $|G| > k$ where $|G|$ denotes the number of (4-valent) nodes in the graph G . The notion of finite type is of extraordinary significance in studying these invariants. One reason for this is the following basic Lemma.

Lemma. *If a graph G has exactly k nodes, then the value of a Vassiliev invariant v_k of type k on G , $v_k(G)$, is independent of the embedding of G .*

Proof. The different embeddings of G can be represented by link diagrams with some of the 4-valent vertices in the diagram corresponding to the nodes of G . It suffices to show that the value of $v_k(G)$ is unchanged under switching of a crossing. However, the exchange identity for v_k shows that this difference is equal to the evaluation of v_k on a graph with $k + 1$ nodes and hence is equal to zero. This completes the proof. \square

The upshot of this lemma is that Vassiliev invariants of type k are intimately involved with certain abstract evaluations of graphs with k nodes. In fact, there are restrictions (the four-term relations) on these evaluations demanded by the topology and it follows from results of Kontsevich [13] that such abstract evaluations actually determine the invariants. The knot invariants derived from classical Lie algebras are all built from Vassiliev invariants of finite type. All this is directly related to Witten's functional integral [14].

In the next few figures we illustrate some of these main points. In Fig. 2 we show how one associates a so-called chord diagram to represent the abstract graph associated

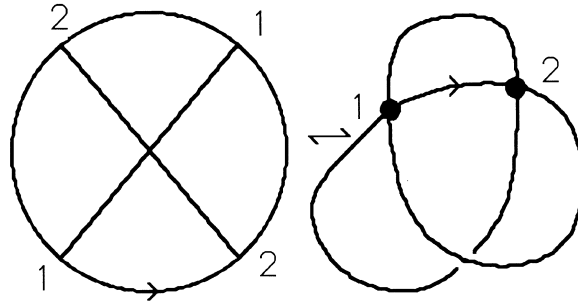

Fig. 2. Chord diagrams.

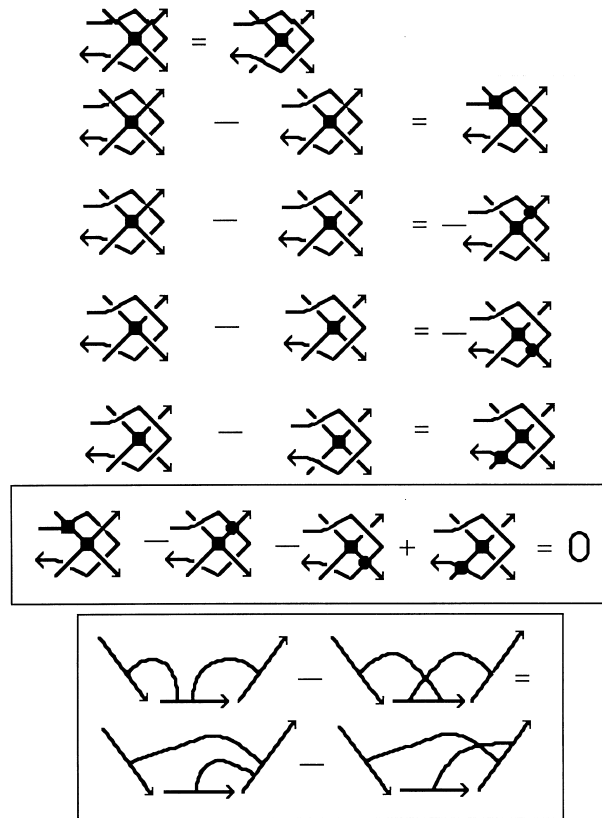

Fig. 3. The four-term relation from topology.

with an embedded graph. The chord diagram is a circle with arcs connecting those points on the circle that are welded to form the corresponding graph. In Fig. 3 we illustrate how the four-term relation is a consequence of topological invariance. In Fig. 4 we show how the four-term relation is a consequence of the abstract pattern of

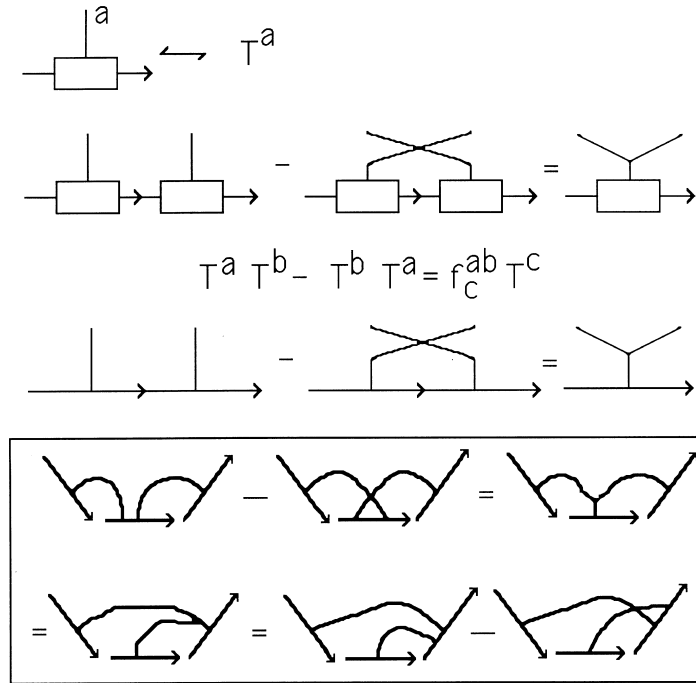

Fig. 4. The four-term relation from categorical Lie algebra.

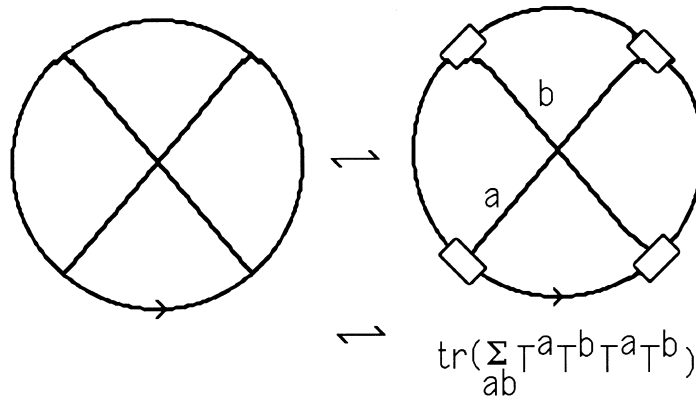

Fig. 5. Calculating Lie algebra weights.

the commutator identity for a matrix Lie algebra. This shows that the four-term relation is directly related to a categorical generalization of Lie algebras. Fig. 5 illustrates how the weights are assigned to the chord diagrams in the Lie algebra case – by inserting Lie algebra matrices into the circle and taking a trace of a sum of matrix products.

3. Vassiliev invariants and Witten's functional integral

In [14] Edward Witten proposed a formulation of a class of 3-manifold invariants as generalized Feynman integrals taking the form $Z(M)$ where

$$Z(M) = \int DA e^{(ik/4\pi)S(M,A)}.$$

Here M denotes a 3-manifold without boundary and A is a gauge field (also called a gauge potential or gauge connection) defined on M . The gauge field is a one-form on a trivial G -bundle over M with values in a representation of the Lie algebra of G . The group G corresponding to this Lie algebra is said to be the gauge group. In this integral the “action” $S(M,A)$ is taken to be the integral over M of the trace of the Chern-Simons three-form $A \wedge dA + (2/3)A \wedge A \wedge A$. (The product is the wedge product of differential forms.)

$Z(M)$ integrates over all gauge fields modulo gauge equivalence. (See Ref. [15] for a discussion of the definition and meaning of gauge equivalence.)

The formalism and internal logic of Witten's integral supports the existence of a large class of topological invariants of 3-manifolds and associated invariants of knots and links in these manifolds.

The invariants associated with this integral have been given rigorous combinatorial descriptions [16–21], but questions and conjectures arising from the integral formulation are still outstanding (see, for example, Refs. [22–27]). Specific conjectures about this integral take the form of just how it implicates invariants of links and 3-manifolds, and how these invariants behave in certain limits of the coupling constant k in the integral. Many conjectures of this sort can be verified through the combinatorial models. On the other hand, the really outstanding conjecture about the integral is that it exists! At the present time there is no measure theory or generalization of measure theory that supports it. Here is a formal structure of great beauty. It is also a structure whose consequences can be verified by a remarkable variety of alternative means.

We now look at the formalism of the Witten integral in more detail and see how it implicates invariants of knots and links corresponding to each classical Lie algebra. In order to accomplish this task, we need to introduce the Wilson loop. The Wilson loop is an exponentiated version of integrating the gauge field along a loop K in three space that we take to be an embedding (knot) or a curve with transversal self-intersections. For this discussion, the Wilson loop will be denoted by the notation $W_K(A) = \langle K|A \rangle$ to denote the dependence on the loop K and the field A . It is usually indicated by the symbolism $tr(Pe^{\oint_K A})$. Thus

$$W_K(A) = \langle K|A \rangle = tr(Pe^{\oint_K A}).$$

Here P denotes path-ordered integration – we are integrating and exponentiating matrix-valued functions, and so must keep track of the order of the operations. The symbol tr denotes the trace of the resulting matrix.

With the help of the Wilson loop functional on knots and links, Witten writes down a functional integral for link invariants in a 3-manifold M :

$$\begin{aligned} Z(M, K) &= \int DA e^{(ik/4\pi)S(M,A)} \text{tr}(P e^{\oint_K A}) \\ &= \int DA e^{(ik/4\pi)S} \langle K|A \rangle . \end{aligned}$$

Here $S(M, A)$ is the Chern–Simons Lagrangian, as in the previous discussion. We abbreviate $S(M, A)$ as S and write $\langle K|A \rangle$ for the Wilson loop. Unless otherwise mentioned, the manifold M will be the three-dimensional sphere S^3 .

An analysis of the formalism of this functional integral reveals quite a bit about its role in knot theory. This analysis depends upon key facts relating the curvature of the gauge field to both the Wilson loop and the Chern–Simons Lagrangian. The idea for using the curvature in this way is due to Lee Smolin [28] (see also Ref. [29]). To this end, let us recall the local coordinate structure of the gauge field $A(x)$, where x is a point in three space. We can write $A(x) = A_k^a(x) T_a dx^k$ where the index a ranges from 1 to m with the Lie algebra basis $\{T_1, T_2, T_3, \dots, T_m\}$. The index k goes from 1 to 3. For each choice of a and k , $A_k^a(x)$ is a smooth function defined on three space. In $A(x)$ we sum over the values of repeated indices. The Lie algebra generators T_a are matrices corresponding to a given representation of the Lie algebra of the gauge group G . We assume some properties of these matrices as follows:

- (1) $[T_a, T_b] = i f^{abc} T_c$ where $[x, y] = xy - yx$, and f^{abc} (the matrix of structure constants) is totally antisymmetric. There is summation over repeated indices.
- (2) $\text{tr}(T_a T_b) = \delta_{ab}/2$ where δ_{ab} is the Kronecker delta ($\delta_{ab} = 1$ if $a = b$ and zero otherwise).

We also assume some facts about curvature. (The reader may enjoy comparing with the exposition in Ref. [30]. But note the difference of conventions on the use of i in the Wilson loops and curvature definitions.) The first fact is the relation of Wilson loops and curvature for small loops:

Fact 1. *The result of evaluating a Wilson loop about a very small planar circle around a point x is proportional to the area enclosed by this circle times the corresponding value of the curvature tensor of the gauge field evaluated at x .*

The curvature tensor is written

$$F_{rs}^a(x) T_a dx^r dy^s .$$

It is the local coordinate expression of $F = dA + A \wedge A$.

Application of Fact 1. Consider a given Wilson line $\langle K|S \rangle$. Ask how its value will change if it is deformed infinitesimally in the neighborhood of a point x on the line. Approximate the change according to Fact 1, and regard the point x as the place of

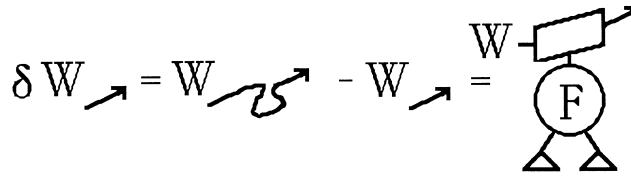

Fig. 6. Lie algebra and curvature tensor insertion into the Wilson loop.

curvature evaluation. Let $\delta\langle K|A \rangle$ denote the change in the value of the line. $\delta\langle K|A \rangle$ is given by the formula

$$\delta\langle K|A \rangle = dx^r dx^s F_a^{rs}(x) T_a \langle K|A \rangle .$$

This is the first-order approximation to the change in the Wilson line.

In this formula it is understood that the Lie algebra matrices T_a are to be inserted into the Wilson line at the point x , and that we are summing over repeated indices. This means that each $T_a \langle K|A \rangle$ is a new Wilson line obtained from the original line $\langle K|A \rangle$ by leaving the form of the loop unchanged, but inserting the matrix T_a into that loop at the point x . In Fig. 6 we have illustrated this mode of insertion of Lie algebra into the Wilson loop. Here and in further illustrations in this section we use $W_K(A)$ to denote the Wilson loop. Note that in the diagrammatic version shown in Fig. 6 we have let small triangles with legs indicate dx^i . The legs correspond to indices just as in our work in the last section with Lie algebras and chord diagrams. The curvature tensor is indicated as a circle with three legs corresponding to the indices of F_a^{rs} .

Notation. In the diagrams in this section we have dropped mention of the factor of $(1/4\pi)$ that occurs in the integral. This convention saves space in the figures. In these figures L denotes the Chern–Simons Lagrangian.

Remark. In thinking about the Wilson line $\langle K|A \rangle = tr(Pe^{\oint_K A})$, it is helpful to recall Euler’s formula for the exponential:

$$e^x = \lim_{n \rightarrow \infty} (1 + x/n)^n .$$

The Wilson line is the limit, over partitions of the loop K , of products of the matrices $(1 + A(x))$ where x runs over the partition. Thus we can write symbolically,

$$\begin{aligned} \langle K|A \rangle &= \prod_{x \in K} (1 + A(x)) \\ &= \prod_{x \in K} (1 + A_k^a(x) T_a dx^k) . \end{aligned}$$

It is understood that a product of matrices around a closed loop connotes the trace of the product. The ordering is forced by the one-dimensional nature of the loop. Insertion of a given matrix into this product at a point on the loop is then a well-defined concept. If T is a given matrix then it is understood that $T \langle K|A \rangle$ denotes the insertion of T

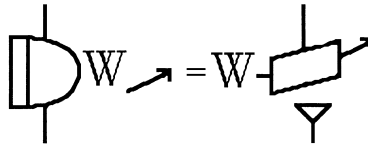

Fig. 7. Differentiating the Wilson line.

into some point of the loop. In the case above, it is understood from context in the formula that the insertion is to be performed at the point x indicated in the argument of the curvature.

Remark. The previous remark implies the following formula for the variation of the Wilson loop with respect to the gauge field:

$$\delta\langle K|A\rangle/\delta(A_k^a(x)) = dx^k T_a\langle K|A\rangle .$$

Varying the Wilson loop with respect to the gauge field results in the insertion of an infinitesimal Lie algebra element into the loop. Fig. 7 gives a diagrammatic form for this formula. In the figure we use a capital D with up and down legs to denote the derivative $\delta/\delta(A_k^a(x))$. Insertions in the Wilson line are indicated directly by matrix boxes placed in a representative bit of line.

Proof.

$$\begin{aligned} &\delta\langle K|A\rangle/\delta(A_k^a(x)) \\ &= \delta \prod_{y \in K} (1 + A_k^a(y)T_a dy^k) / \delta(A_k^a(x)) \\ &= \prod_{y < x \in K} (1 + A_k^a(y)T_a dy^k) [T_a dx^k] \prod_{y > x \in K} (1 + A_k^a(y)T_a dy^k) \\ &= dx^k T_a \langle K|A\rangle . \end{aligned}$$

Fact 2. *The variation of the Chern–Simons Lagrangian S with respect to the gauge potential at a given point in three-space is related to the values of the curvature tensor at that point by the following formula:*

$$F_{rs}^a(x) = \varepsilon_{rst} \delta S / \delta(A_t^a(x)) .$$

Here ε_{abc} is the epsilon symbol for three indices, i.e. it is +1 for positive permutations of 123 and –1 for negative permutations of 123 and zero if any two indices are repeated. A diagrammatic for this formula is shown in Fig. 8.

With these facts at hand we are prepared to determine how the Witten integral behaves under a small deformation of the loop K .

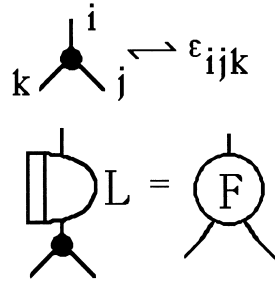

Fig. 8. Variational formula for curvature.

Theorem. (1) Let $Z(K) = Z(S^3, K)$ and let $\delta Z(K)$ denote the change of $Z(K)$ under an infinitesimal change in the loop K . Then

$$\delta Z(K) = (4\pi i/k) \int dA e^{(ik/4\pi)S} [Vol] T_a T_a \langle K|A \rangle,$$

where $Vol = \epsilon_{rst} dx^r dx^s dx^t$.

The sum is taken over repeated indices, and the insertion is taken of the matrices $T_a T_a$ at the chosen point x on the loop K that is regarded as the “center” of the deformation. The volume element $Vol = \epsilon_{rst} dx^r dx^s dx^t$ is taken with regard to the infinitesimal directions of the loop deformation from this point on the original loop.

(2) The same formula applies, with a different interpretation, to the case where x is a double point of transversal self-intersection of a loop K , and the deformation consists in shifting one of the crossing segments perpendicularly to the plane of intersection so that the self-intersection point disappears. In this case, one T_a is inserted into each of the transversal crossing segments so that $T_a T_a \langle K|A \rangle$ denotes a Wilson loop with a self intersection at x and insertions of T_a at $x + \epsilon_1$ and $x + \epsilon_2$ where ϵ_1 and ϵ_2 denote small displacements along the two arcs of K that intersect at x . In this case, the volume form is nonzero, with two directions coming from the plane of movement of one arc, and the perpendicular direction is the direction of the other arc.

Proof.

$$\begin{aligned} \delta Z(K) &= \int DA e^{(ik/4\pi)S} \delta \langle K|A \rangle \\ &= \int DA e^{(ik/4\pi)S} dx^r dy^s F_{rs}^a(x) T_a \langle K|A \rangle \\ &= \int DA e^{(ik/4\pi)S} dx^r dy^s \epsilon_{rst} (\delta S / \delta(A_t^a(x))) T_a \langle K|A \rangle \\ &= (-4\pi i/k) \int DA (\delta e^{(ik/4\pi)S} / \delta(A_t^a(x))) \epsilon_{rst} dx^r dy^s T_a \langle K|A \rangle \\ &= (4\pi i/k) \int DA e^{(ik/4\pi)S} \epsilon_{rst} dx^r dy^s (\delta T_a \langle K|A \rangle / \delta(A_t^a(x))) \end{aligned}$$

$$\begin{aligned}
 \delta Z_{\rightarrow} &= \int DA e^{ikL} \delta W_{\rightarrow} \\
 &= \int DA e^{ikL} \text{ (Diagram 1) } \\
 &= \int DA e^{ikL} \text{ (Diagram 2) } \\
 &= (-i/k) \int DA \text{ (Diagram 3) } \\
 &= (i/k) \int DA e^{ikL} \text{ (Diagram 4) } \\
 &= (i/k) \int DA e^{ikL} \text{ (Diagram 5) }
 \end{aligned}$$

Fig. 9. Varying the functional integral by varying the line.

(integration by parts and the boundary terms vanish)

$$= (4\pi i/k) \int DA e^{(ik/4\pi)S} [\text{Vol}] T_a T_a \langle K|A \rangle .$$

This completes the formalism of the proof. In the case of part (2), a change of interpretation occurs at the point in the argument when the Wilson line is differentiated. Differentiating a self-intersecting Wilson line at a point of self-intersection is equivalent to differentiating the corresponding product of matrices with respect to a variable that occurs at two points in the product (corresponding to the two places where the loop passes through the point). One of these derivatives gives rise to a term with volume form equal to zero, the other term is the one that is described in part (2). This completes the proof of the theorem. \square

The formalism of this proof is illustrated in Fig. 9.

$$\begin{aligned}
 Z \text{ (crossing with dot)} &= Z \text{ (crossing 1)} - Z \text{ (crossing 2)} \\
 &= (c/k) Z \text{ (crossing with loop)} + O(1/k^2)
 \end{aligned}$$

Fig. 10. The difference formula.

In the case of switching a crossing the key point is to write the crossing switch as a composition of first moving a segment to obtain a transversal intersection of the diagram with itself, and then to continue the motion to complete the switch. One then analyses separately the case where x is a double point of transversal self-intersection of a loop K , and the deformation consists in shifting one of the crossing segments perpendicularly to the plane of intersection so that the self-intersection point disappears. In this case, one T_a is inserted into each of the transversal crossing segments so that $T^a T^a \langle K|A \rangle$ denotes a Wilson loop with a self-intersection at x and insertions of T^a at $x + \varepsilon_1$ and $x + \varepsilon_2$ as in part (2) of the theorem above. The first insertion is in the moving line, due to curvature. The second insertion is the consequence of differentiating the self-touching Wilson line. Since this line can be regarded as a product, the differentiation occurs twice at the point of intersection, and it is the second direction that produces the non-vanishing volume form.

Up to the choice of our conventions for constants, the switching formula is, as shown below (see Fig. 10)

$$\begin{aligned}
 Z(K_+) - Z(K_-) &= (4\pi i/k) \int DA e^{(ik/4\pi)S} T_a T_a \langle K_{**}|A \rangle \\
 &= (4\pi i/k) Z(T^a T^a K_{**}),
 \end{aligned}$$

where K_{**} denotes the result of replacing the crossing by a self-touching crossing. We distinguish this from adding a graphical node at this crossing by using the double-star notation.

A key point is to notice that the Lie algebra insertion for this difference is exactly what is done (in chord diagrams) to make the weight systems for Vassiliev invariants (without the framing compensation). Here we take formally the perturbative expansion of the Witten integral to obtain Vassiliev invariants as coefficients of the powers of $(1/k^n)$. Thus, the formalism of the Witten functional integral takes one directly to these weight systems in the case of the classical Lie algebras. In this way the functional integral is central to the structure of the Vassiliev invariants.

$$\hat{\Psi}(K) = \int DA \Psi(A) W_K$$

$$\begin{aligned} \Delta \hat{\Psi}(K) &= \int DA \Delta \Psi(A) W_K \\ &= - \int DA \Psi(A) \Delta W_K \end{aligned}$$

Fig. 11. The loop transform and operators G and H .

3.1. The loop transform

Suppose that $\psi(A)$ is a (complex-valued) function defined on gauge fields. Then we define formally the *loop transform* $\hat{\psi}(K)$, a function on embedded loops in three-dimensional space, by the formula

$$\hat{\psi}(K) = \int DA \psi(A) W_K(A).$$

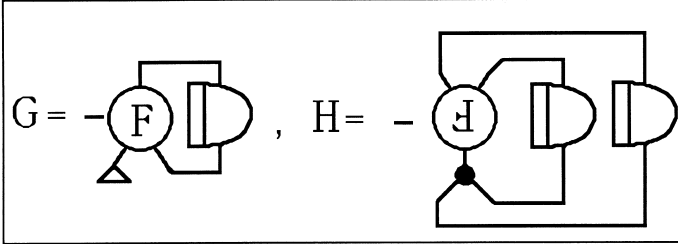
If Δ is a differential operator defined on $\psi(A)$, then we can use this integral transform to shift the effect of Δ to an operator on loops via integration by parts:

$$\begin{aligned} \Delta \hat{\psi}(K) &= \int DA \Delta \psi(A) W_K(A) \\ &= - \int DA \psi(A) \Delta W_K(A). \end{aligned}$$

When Δ is applied to the Wilson loop the result can be an understandable geometric or topological operation. In Figs. 11–13 we illustrate this situation with diagrammatically defined operators G and H .

$$\begin{aligned}
 \widehat{G}\Psi(\rightarrow) &= \int DA G\Psi W_{\rightarrow} = - \int DA \Psi GW_{\rightarrow} \\
 &= \int DA \Psi \text{ (Diagram 1) } W_{\rightarrow} \\
 &= \int DA \Psi \text{ (Diagram 2) } W_{\rightarrow} = \int DA \Psi \delta W_{\rightarrow}
 \end{aligned}$$

Fig. 12. The diffeomorphism constraint.

$$\begin{aligned}
 \widehat{H}\Psi(\rightarrow) &= \int DA \Psi \text{ (Diagram 3) } W_{\rightarrow} \\
 &= \int DA \Psi W \text{ (Diagram 4) } \\
 &= \int DA \Psi W \text{ (Diagram 5) }
 \end{aligned}$$

Fig. 13. The Hamiltonian constraint.

We see from Fig. 12 that

$$\widehat{G}\psi(K) = \delta\hat{\psi}(K),$$

where this variation refers to the effect of varying K by a small loop. As we saw in this section, this means that if $\hat{\psi}(K)$ is a topological invariant of knots and links, then $\widehat{G}\psi(K) = 0$ for all embedded loops K . This condition is a transform analogue of the equation $G\psi(A) = 0$. This equation is the differential analogue of an invariant of knots and links. It may happen that $\delta\hat{\psi}(K)$ is not strictly zero, as in the case of our framed knot invariants. For example with

$$\psi(A) = e^{(ik/4\pi) \int \text{tr}(A \wedge dA + (2/3)A \wedge A \wedge A)}$$

we conclude that $\widehat{G}\psi(K)$ is zero for flat deformations (in the sense of this section) of the loop K , but can be non-zero in the presence of a twist or curl. In this sense the loop transform provides a subtle variation on the strict condition $G\psi(A) = 0$.

In [5] and earlier publications by these authors, the loop transform is used to study a reformulation and quantization of Einstein gravity. The differential geometric gravity theory is reformulated in terms of a background gauge connection and in the quantization, the Hilbert space consists of functions $\psi(A)$ that are required to satisfy the constraints

$$G\psi = 0$$

and

$$H\psi = 0,$$

where H is the operator shown in Fig. 13. Thus we see that $\hat{G}(K)$ can be partially zero in the sense of producing a framed knot invariant, and (from Fig. 13 and the antisymmetry of the epsilon) that $\hat{H}(K)$ is zero for non-self-intersecting loops. This means that the loop transforms of G and H can be used to investigate a subtle variation of the original scheme for the quantization of gravity. This program is being actively pursued by a number of researchers. The Vassiliev invariants arising from a topologically invariant loop transform should be of significance to this theory. This theme will be explored in a subsequent paper.

4. The three-dimensional perturbative expansion

In this section we will first show how linking and self-linking numbers arise from the functional integral, and then how this formalism generalizes to produce combinations of space integrals that express Vassiliev invariants. See Ref. [1] for a treatment of the gauge fixing that is relevant to this approach. Here we will follow a heuristic that avoids gauge-fixing altogether. This makes the derivation in this section wholly heuristic even from the physical point of view, but it is worth the experiment since it actually does come up with a correct topological answer as the work of Bott and Taubes [7] and Altschuler–Friedel [6] shows.

Let us begin with a simple vector field $(A_1(x), A_2(x), A_3(x)) = A(x)$ where x is a point in three-dimensional Euclidean space R^3 . This is equivalent to taking the circle ($U(1)$) as gauge group. Now consider fields of the form $A + \phi$ where ϕ is a scalar field (regarded as a fourth coordinate if you like). Define an operator L on $A + \phi$ by the formula

$$L(A + \phi) = -\nabla \times A - \nabla \cdot A + \nabla \phi;$$

then it is easy to see that

$$L^2(A + \phi) = -\nabla^2(A) - \nabla^2(\phi).$$

If we identify A with the one-form $A_1 dx^1 + A_2 dx^2 + A_3 dx^3$, then

$$\int_{R^3} \text{tr}(A \wedge dA) = \int_{R^3} A \cdot (\nabla \times A) \text{dvol},$$

where dvol denotes the volume form on R^3 and the A appearing on the right-hand part of the above formula is the vector field version of A . Since we are integrating with respect to volume, the scalar part of $L(A)$ does not matter and we can write

$$\int_{R^3} \text{tr}(A \wedge dA) = \int_{R^3} A \cdot L(A) \text{dvol}$$

and take as a definition of a quadratic form on vector fields

$$\langle A, B \rangle = \int_{R^3} A \cdot B \text{dvol}$$

so that

$$\langle A, LA \rangle = \int_{R^3} \text{tr}(A \wedge dA).$$

With this in mind, consider the following functional integral defined for a link of two components K and K' :

$$\Lambda(K, K') = \int DA e^{-(1/2)\langle A, LA \rangle} \int \int_{(x,y) \in K \times K'} A(x)A(y).$$

Regarding this as a Gaussian integral, we need to determine the inverse of the operator L . Within the context of the quadratic form we have $L^2 = -\nabla^2$. We know that the Green's function

$$G = (-1/4\pi)(1/|x - y|)$$

is the inverse of the three-dimensional Laplacian

$$\nabla^2 G(x) = \delta(x - y),$$

where $\delta(x - y)$ denotes the Dirac delta function.

Thus if $J(y)$ stands for an arbitrary vector field, and we define

$$G * J = \int_{R^3} dy G(x - y)J(y),$$

then

$$\begin{aligned} (\nabla^2 G) * J(x) &= \int_{R^3} dy \nabla^2 G(x - y) J(y) \\ &= \int_{R^3} dy \delta(x - y) J(y) = J(x). \end{aligned}$$

Thus

$$(L^2 G) * J = J.$$

Hence

$$L((LG) * J) = J$$

and

$$L^{-1}J = (LG) * J.$$

It is then easy to calculate that

$$\langle J, L^{-1}J \rangle = (1/4\pi) \int \int_{K \times K'} (J(x) \times J(y)) \cdot (x - y) / |x - y|^3.$$

Now returning to our functional integral we have

$$\begin{aligned} A(K, K') &= \int DA e^{-(1/2)\langle A, LA \rangle} \int \int_{(x,y) \in K \times K'} A(x)A(y) \\ &= \int \int_{K \times K'} \int DA e^{(-1/2)\langle A, LA \rangle} A(x)A(y) \\ &= \int \int_{K \times K'} \partial/\partial J(x) \partial/\partial J(y) |_{J=0} e^{(1/2)\langle J, L^{-1}J \rangle}. \end{aligned}$$

The last equality, being the basic hypothesis for evaluating the functional integral.

Using our results on L^{-1} and a few calculations suppressed here, we conclude that

$$\begin{aligned} A(K, K') &= (1/4\pi) \int \int_{K \times K'} (dx \times dy) \cdot (x - y) / |x - y|^3 \\ &= Lk(K, K'). \end{aligned}$$

Here $L(K, K')$ denotes the linking number of the curves K and K' . The last equality is the statement of Gauss's integral representation for the linking number of two space curves.

Now consider the Witten functional integral for arbitrary gauge group. Then one can check that a formula of the following type expresses the trace of the Chern–Simons differential form. Here f_{abc} denotes the structure constants for the Lie algebra

$$tr(A dA + (2/3)A^3) = (\epsilon^{ijk}/2) \left[\sum_a A_i^a \partial_j A_k^a + (1/3) \sum_{a,b,c} A_i^a A_j^b A_k^c f_{abc} \right] dvol.$$

This means that we can think of this trace as a sum of a Gaussian term directly analogous to the term for the linking number (but involving the Lie algebra indices)

and a separate term corresponding to the A^3 term in the Chern–Simons form. We want the coefficient of the Gaussian term in the integral to be constant (independent of the coupling constant k). To accomplish this, we replace A by A/\sqrt{k} and obtain

$$Z_K = \int DA e^{(i/4\pi) \int tr(A dA)} e^{(i/4\pi\sqrt{k}) \int tr(2/3)A^3} \sum_n (1/\sqrt{k})^n \int \int \cdots \int_{K_1 < K_2 < \cdots < K_n} A^n .$$

Here we have used an expansion of the Wilson loop as a sum of integrated integrals:

$$\begin{aligned} W_K(A) &= tr \prod_{x \in K} (1 + A/\sqrt{k}) \\ &= \sum_n (1/\sqrt{k})^n \int \int \cdots \int_{K_1 < K_2 < \cdots < K_n} A^n . \end{aligned}$$

The notation $K_1 < K_2 < \cdots < K_n$ means that in the integration process we choose points x_i from K so that $x_1 < x_2 < \cdots < x_n$ and the term A^n in the integration formula denotes $A(x_1)A(x_2) \dots A(x_n)$. With this reformulation of Z_K , we see that the full integral can be considered as a Gaussian integral with correlations corresponding to the products of copies of A in the iterated integrals and other products involving the A^3 term. We will explicate this integration heuristically, without doing any gauge fixing.

Using

$$e^{(i/4\pi\sqrt{k}) \int tr(2/3)A^3} = \sum_m (1/m!) (i/6\pi\sqrt{k})^m \left(\int tr(A^3) \right)^m ,$$

substituting and rewriting, we have

$$Z_K = \sum_m \sum_n (1/m!) (i/6\pi)^m (1/\sqrt{k})^{m+n} C_{mn}$$

where

$$C_{mn} = \int DA e^{(i/4\pi) \int tr(A dA)} \int tr(A^3)^m \int \int \cdots \int_{K_1 < K_2 < \cdots < K_n} A^n .$$

The term C_{mn} shows that we will have to consider correlations combined from the Wilson loop and from the A^3 term. The quadratic form $\int tr(A dA)$ is a direct generalization of the quadratic form that we explicated at the beginning of the section and the inverse operator is obtained by applying the Laplacian to the same Green’s function. As a result, the Feynman diagrams for these correlations have triple vertices in space (corresponding to the A^3 term) and single vertices on the knot or link (corresponding to an A in the iterated integral. Each triple vertex contributes $1/\sqrt{k}$ and each vertex on the link also contributes $1/\sqrt{k}$. At a triple vertex there is a factor proportional to

$$\varepsilon^{ijk} f_{abc}$$

(coming from the expression we gave earlier in this section for $tr(A dA + (2/3)A^3)$). At a single vertex (corresponding to one A), there is an insertion of Lie algebra in the line (i.e., the knot or link), and along each edge in the Feynman diagram there is a Gauss kernel (the propagator) $i/4\pi \delta_{ab} \varepsilon^{ijk} (x-y)_k / |x-y|^3$. This is tied into the relevant indices which are the indices of tangent directions along the lines of the link and the factors

at the triple vertices. For a given order of diagram one integrates the positions of the vertices along the link and the positions of the triple vertices in three-dimensional space to obtain the contribution of the diagram to the correlator. In this way, a given C_{mn} contributes to the order $(1/\sqrt{k})^{m+n}$ of the perturbative expansion of the integral. By taking an appropriate sum of the C_{mn} for $m+n=2N$ one obtains an explicit formula for the N th-order Vassiliev invariants arising from the functional integral.

5. Wilson lines, light-cone gauge and the Kontsevich integrals

In this section we follow the gauge fixing method used by Fröhlich and King [4]. Their paper was written before the advent of Vassiliev invariants, but contains, as we shall see, nearly the whole story about the Kontsevich integral. A similar approach to ours can be found in Ref. [3]. In our case we have simplified the determination of the inverse operator for this formalism and we have given a few more details about the calculation of the correlation functions than is customary in physics literature. I hope that this approach makes this subject more accessible to mathematicians. A heuristic argument of this kind contains a great deal of valuable mathematics. It is clear that these matters will eventually be given a fully rigorous treatment. In fact, in the present case there is a rigorous treatment, due to Albevario and Sen-Gupta [31] of the functional integral *after* the light-cone gauge has been imposed.

Let (x^0, x^1, x^2) denote a point in three-dimensional space. Change to light-cone coordinates

$$x^+ = x^1 + x^2$$

and

$$x^- = x^1 - x^2.$$

Let t denote x^0 .

Then the gauge connection can be written in the form

$$A(x) = A_+(x)dx^+ + A_-(x)dx^- + A_0(x)dt.$$

Let $CS(A)$ denote the Chern–Simons integral (over the three-dimensional sphere)

$$CS(A) = (1/4\pi) \int tr(A \wedge dA + (2/3)A \wedge A \wedge A).$$

We define *axial gauge* (light-cone gauge) to be the condition that $A_- = 0$. We shall now work with the functional integral of the previous section under the axial gauge restriction. In axial gauge we have that $A \wedge A \wedge A = 0$ and so

$$CS(A) = (1/4\pi) \int tr(A \wedge dA).$$

Letting ∂_{\pm} denote partial differentiation with respect to x^{\pm} , we get the following formula in axial gauge:

$$A \wedge dA = (A_+ \partial_- A_0 - A_0 \partial_- A_+) dx^+ \wedge dx^- \wedge dt.$$

Thus, after integration by parts, we obtain the following formula for the Chern–Simons integral:

$$CS(A) = (1/2\pi) \int tr(A_+ \partial_- A_0) dx^+ \wedge dx^- \wedge dt .$$

Letting ∂_i denote the partial derivative with respect to x_i , we have that

$$\partial_+ \partial_- = \partial_1^2 - \partial_2^2 .$$

If we replace x^2 with ix^2 where $i^2 = -1$, then $\partial_+ \partial_-$ is replaced by

$$\partial_1^2 + \partial_2^2 = \nabla^2 .$$

We now make this replacement so that the analysis can be expressed over the complex numbers.

Letting

$$z = x^1 + ix^2 ,$$

it is well known that

$$\nabla^2 \ln(z) = 2\pi\delta(z) ,$$

where $\delta(z)$ denotes the Dirac delta function and $\ln(z)$ is the natural logarithm of z . Thus we can write

$$(\partial_+ \partial_-)^{-1} = (1/2\pi)\ln(z) .$$

Note that $\partial_+ = \partial_z = \partial/\partial z$ after the replacement of x^2 by ix^2 . As a result we have that

$$(\partial_-)^{-1} = \partial_+ (\partial_+ \partial_-)^{-1} = \partial_+ (1/2\pi)\ln(z) = 1/2\pi z .$$

Now that we know the inverse of the operator ∂_- we are in a position to treat the Chern–Simons integral as a quadratic form in the pattern

$$(-1/2)\langle A, LA \rangle = -iCS(A) ,$$

where the operator

$$L = \partial_- .$$

Since we know L^{-1} , we can express the functional integral as a Gaussian integral.

We replace

$$Z(K) = \int DA e^{ikCS(A)} tr(Pe^{\oint_k A})$$

by

$$Z(K) = \int DA e^{iCS(A)} tr(Pe^{\oint_k A/\sqrt{k}})$$

by sending A to $(1/\sqrt{k})A$. We then replace this version by

$$Z(K) = \int DA e^{(-1/2)\langle A, LA \rangle} tr(Pe^{\oint_k A/\sqrt{k}}) .$$

In this last formulation we can use our knowledge of L^{-1} to determine the correlation functions and express $Z(K)$ perturbatively in powers of $(1/\sqrt{k})$.

Proposition. *Letting*

$$\langle \phi(A) \rangle = \int DA e^{(-1/2)\langle A, LA \rangle} \phi(A) \Big/ \int DA e^{(-1/2)\langle A, LA \rangle}$$

for any functional $\phi(A)$, we find that

$$\langle A_+^a(z, t) A_+^b(w, s) \rangle = 0,$$

$$\langle A_0^a(z, t) A_0^b(w, s) \rangle = 0,$$

$$\langle A_+^a(z, t) A_0^b(w, s) \rangle = \kappa \delta^{ab} \delta(t - s) / (z - w)$$

where κ is a constant.

Proof (sketch).

Let us recall how these correlation functions are obtained. The basic formalism for the Gaussian integration is in the pattern

$$\begin{aligned} \langle A(z)A(w) \rangle &= \int DA e^{(-1/2)\langle A, LA \rangle} A(z)A(w) \Big/ \int DA e^{(-1/2)\langle A, LA \rangle} \\ &= ((\partial/\partial J(z))(\partial/\partial J(w))|_{J=0}) e^{(1/2)\langle J, L^{-1}J \rangle}. \end{aligned}$$

Letting $G * J(z) = \int dw G(z - w)J(w)$, we have that when

$$LG(z) = \delta(z)$$

($\delta(z)$ is a Dirac delta function of z .) then

$$LG * J(z) = \int dw LG(z - w)J(w) = \int dw \delta(z - w)J(w) = J(z).$$

Thus $G * J(z)$ can be identified with $L^{-1}J(z)$.

In our case

$$G(z) = 1/2\pi z$$

and

$$L^{-1}J(z) = G * J(z) = \int dw J(w)/(z - w).$$

Thus

$$\begin{aligned} \langle J(z), L^{-1}J(z) \rangle &= \langle J(z), G * J(z) \rangle = (1/2\pi) \int tr J(z) \left(\int dw J(w)/(z - w) \right) dz \\ &= (1/2\pi) \int \int dz dw tr(J(z)J(w))/(z - w). \end{aligned}$$

The results on the correlation functions then follow directly from differentiating this expression. Note that the Kronecker delta on Lie algebra indices is a result of the

corresponding Kronecker delta in the trace formula $tr(T_a T_b) = \delta_{ab}/2$ for products of Lie algebra generators. The Kronecker delta for the $x^0=t, s$ coordinates is a consequence of the evaluation at J equal to zero. \square

We are now prepared to give an explicit form to the perturbative expansion for

$$\begin{aligned} \langle K \rangle &= Z(K) \int DAe^{(-1/2)\langle A, LA \rangle} \\ &= \int DAe^{(-1/2)\langle A, LA \rangle} tr(Pe^{\oint_K A/\sqrt{k}}) \int DAe^{(-1/2)\langle A, LA \rangle} \\ &= \int DAe^{(-1/2)\langle A, LA \rangle} tr \left(\prod_{x \in K} (1 + (A/\sqrt{k})) \right) \int DAe^{(-1/2)\langle A, LA \rangle} \\ &= \sum_n (1/k^{n/2}) \oint_{K_1 < \dots < K_n} \langle A(x_1) \dots A(x_n) \rangle . \end{aligned}$$

The latter summation can be rewritten (Wick expansion) into a sum over products of pair correlations, and we have already worked out the values of these. In the formula above we have written $K_1 < \dots < K_n$ to denote the integration over variables x_1, \dots, x_n on K so that $x_1 < \dots < x_n$ in the ordering induced on the loop K by choosing a basepoint on the loop. After the Wick expansion, we get

$$\langle K \rangle = \sum_m (1/k^m) \oint_{K_1 < \dots < K_n} \sum_{P=\{x_i < x'_i \mid i=1, \dots, m\}} \prod_i \langle A(x_i) A(x'_i) \rangle .$$

Now we know that

$$\langle A(x_i) A(x'_i) \rangle = \langle A_k^a(x_i) A_l^b(x'_i) \rangle T_a T_b dx^k dx^l .$$

Rewriting this in the complexified axial gauge coordinates, the only contribution is

$$\langle A_+^a(z, t) A_0^b(s, w) \rangle = \kappa \delta^{ab} \delta(t - s) / (z - w) .$$

Thus

$$\begin{aligned} \langle A(x_i) A(x'_i) \rangle &= \langle A_+^a(x_i) A_0^a(x'_i) \rangle T_a T_a dx^+ \wedge dt + \langle A_0^a(x_i) A_+^a(x'_i) \rangle T_a T_a dx^+ \wedge dt \\ &= (dz - dz') / (z - z') [i/i'] , \end{aligned}$$

where $[i/i']$ denotes the insertion of the Lie algebra elements $T_a T_a$ into the Wilson loop.

As a result, for each partition of the loop and choice of pairings $P = \{x_i < x'_i \mid i = 1, \dots, m\}$ we get an evaluation D_P of the trace of these insertions into the loop. This is the value of the corresponding chord diagram in the weight systems for Vassiliev invariants. These chord diagram evaluations then figure in our formula as shown below:

$$\langle K \rangle = \sum_m (1/k^m) \sum_P D_P \oint_{K_1 < \dots < K_n} \bigwedge_{i=1}^m (dz_i - dz'_i) / (z_i - z'_i) .$$

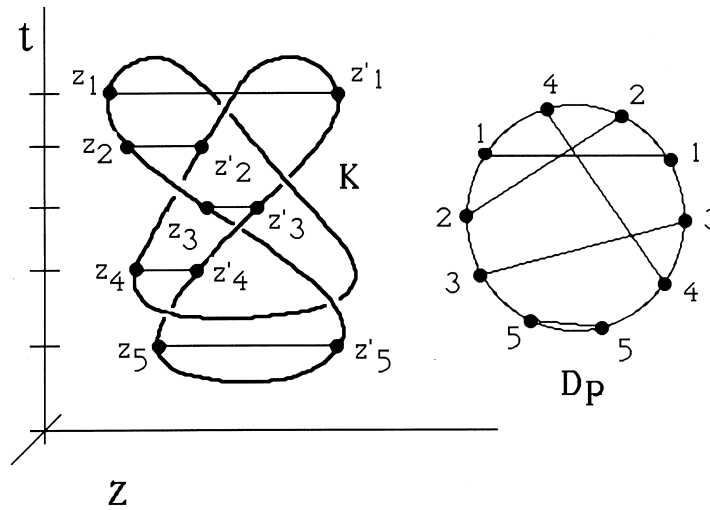

Fig. 14. Applying the Kontsevich integral.

This is a Wilson loop ordering version of the Kontsevich integral. To see the usual form of the integral appear, we change from the time variable (parametrization) associated with the loop itself to time variables associated with a specific global direction of time in three-dimensional space that is perpendicular to the complex plane defined by the axial gauge coordinates. It is easy to see that this results in one change of sign for each segment of the knot diagram supporting a pair correlation where the segment is oriented (Wilson loop parameter) downward with respect to the global time direction. This results in the rewrite of our formula to

$$\langle K \rangle = \sum_m (1/k^m) \sum_P (-1)^{|P \downarrow|} D_P \int_{t_1 < \dots < t_n} \prod_{i=1}^m (dz_i - dz'_i) / (z_i - z'_i),$$

where $|P \downarrow|$ denotes the number of points (z_i, t_i) or (z'_i, t_i) in the pairings where the knot diagram is oriented downward with respect to global time. The integration around the Wilson loop has been replaced by integration in the vertical time direction and is so indicated by the replacement of $\{K_1 < \dots < K_n\}$ with $\{t_1 < \dots < t_n\}$.

The coefficients of $1/k^m$ in this expansion are exactly the Kontsevich integrals for the weight systems D_P ; see Fig. 14.

It was Kontsevich's insight to see (by different means) that these integrals could be used to construct Vassiliev invariants from arbitrary weight systems satisfying the four-term relations. Here we have seen how these integrals arise naturally in the axial gauge fixing of the Witten functional integral.

Remark. The careful reader will note that we have not made a discussion of the role of the maxima and minima of the space curve of the knot with respect to the height direction (t). In fact, one has to take these maxima and minima very carefully into account and to divide by the corresponding evaluated loop pattern (with these maxima

and minima) to make the Kontsevich integral well-defined and actually invariant under ambient isotopy (with appropriate framing correction as well). The corresponding difficulty appears here in the fact that because of the gauge choice the Wilson lines are actually only defined in the complement of the maxima and minima and one needs to analyse a limiting procedure to take care of the inclusion of these points in the Wilson line. This points to one of the places where this correspondence with the Kontsevich integrals as Feynman integrals for Witten's functional integral could stand closer mathematical scrutiny. One purpose of this paper has been to outline the correspondences that exist and to put enough light on the situation to allow a full story to eventually appear.

6. Formal integration

In light of the fact that many beautiful and rigorous results come forth from the formal manipulation of functional integrals, it is of interest to attempt to see whether one can create a formal (essentially combinatorial) category in which these manipulations can exist. This section is devoted to some very elementary remarks along this line.

Suppose that we start with an extended real line in the sense of Robinson's non-standard analysis [32,33]. (For a delightful introduction to a similar construction of an extended real line see also Conway's work on Surreal numbers [34].) In this line there are infinitesimals δ each less than any standard real and the extended line is still a field. Can we make formal integrals that make sense of Leibniz's $\int_a^b f(x)dx$ as a "sum" over infinitely many small quantities?

The yoga for the usual Robinson approach is to define a Riemann sum $S(\Delta x) = \sum_{i=0}^n f(x_i)\Delta x$ where $\{x_0, \dots, x_n\}$ is a partition of the interval $[a, b]$ and $n\Delta x = b - a$. The Riemann sum is regarded as a function of Δx , and then by the Robinson logic of transferring statements about reals to statements about hyperreals, one can let Δx be infinitesimal to define the integral.

Here, I want to note that there is a very formal counterpart to this process that lets one define an indefinite "micro-integral" by a straightforward formula where δ is an infinitesimal:

$$F(x) = f(x)\delta + f(x - \delta)\delta + f(x - 2\delta)\delta + \dots$$

I claim that $F(x)$ is a formal representative for $\int^x f(t)dt$. In particular, let us compute the derivative of F :

$$F(x + \delta) = f(x + \delta)\delta + f(x)\delta + f(x - \delta)\delta + f(x - 2\delta)\delta + \dots$$

Thus

$$(F(x + \delta) - F(x))/\delta = f(x + \delta).$$

Every finite hyperreal is a unique sum of a real and an infinitesimal. The derivative of a function is defined to be the real part of the difference quotient using δ . It follows that

$$F'(x) = f(x).$$

In this sense, we can directly write down a formal antiderivative for a real-valued function $f(x)$.

How far are we on the road towards writing down a formal version of a functional integral in gauge field theory? Is there a combinatorial formula for

$$Z(M, K) = \int DA e^{(ik/4\pi)S(M, A)} \text{tr}(P e^{\oint_K A})$$

utilizing an orchestration of *countable* sums of infinitesimals from the hyperreals? If we do make such a construction it may, like our toy example $F(x)$, be itself infinitesimal, or even infinite. The problem is to make it well-defined in the hyperreals and so that the typical results about integrating Gaussians are logical consequences of its construction. That is the question!

Since I do not have an answer to this question at this writing, let me add a few more ideas. There is another approach to the infinitesimal calculus due to Lawvere and Bell [35] that uses *square zero infinitesimals*. These are infinitesimals ε such that $\varepsilon^2 = 0$. Of course, the extension of the reals to these new hyperreals is no longer a field. Furthermore, these structures are usually wrapped in a cloak of intuitionistic mathematics and category theory (topos theory – see Refs. [35,36]). The intuitionism comes from the desire that ε be indistinguishable from zero and yet not zero. Such subtlety is possible in a world where the double negative is distinct from an affirmation.

The square zero infinitesimals are charming. In this system, the formula

$$f(x + \varepsilon) = f(x) + f'(x)\varepsilon$$

defines the derivative of $f(x)$, and all the familiar properties of derivatives follow easily.

Now square zero infinitesimals remind the differential geometer immediately of Grassmann algebra and exterior differential forms. Actually, there are two significant choices that one can make at this fundamental level. One can choose to assume that distinct square zero infinitesimals commute with one another, and do not necessarily annihilate each other when multiplied. Or one can assume that they do not necessarily commute, but that the squares of any finite sum of them is itself of square zero. Let us consider these two choices one at a time.

In the case of commuting square zero infinitesimals α and β , we have

$$\begin{aligned} (\alpha + \beta)^2 &= \alpha^2 + 2\alpha\beta + \beta^2 \\ &= 2\alpha\beta, \end{aligned}$$

while

$$(\alpha + \beta)^3 = 0.$$

In general, the commutative situation forces higher and higher orders of nilpotency for sums of independent infinitesimals. An *infinite sum* of square zero infinitesimals can stand for a standard Robinson infinitesimal. This indicates that the Robinson theory should be seen as the limit of square zero theories. This is the analog of thinking of a Taylor series in terms of its truncations.

In the case of all sums having square zero and non-commutation, we recover an infinitesimal version of Grassmann algebra:

$$\begin{aligned} 0 &= (\alpha + \beta)^2 = \alpha^2 + \alpha\beta + \beta\alpha + \beta^2 \\ &= \alpha\beta + \beta\alpha . \end{aligned}$$

Thus

$$0 = \alpha\beta + \beta\alpha .$$

I take these elementary observations as hints that the correct version of calculus for our purposes will contain infinitesimals that partake of all these options, and that we should press ahead and create the theory that contains them.

7. Background

For the reader interested in pursuing the background of this paper related to link invariants and topological quantum field theory, we have included references [37–54].

Acknowledgements

It gives the author pleasure to thank Louis Licht, Chris King and Jurg Fröhlich for helpful conversations and to thank the National Science Foundation for support of this research under NSF Grant DMS-9205277 and the NSA for partial support under grant number MSPF-96G-179.

References

- [1] D. Bar-Natan, Perturbative aspects of the Chern–Simons topological quantum field theory, Ph. D. Thesis, Princeton University, June 1991.
- [2] L.H. Kauffman, Witten’s integral and the Kontsevich integrals, in: Jakub Rembliński (Ed.), *Particles, Fields, and Gravitation*, Proceedings of the Conference on Mathematical Physics, AIP Conference Proceedings, Vol. 453, Lodz, Poland, April 1998, pp. 368–381.
- [3] J.M.F. Labastida, E. Pérez, Kontsevich integral for Vassiliev invariants from Chern–Simons perturbation theory in the light-cone gauge, *J. Math. Phys.* 39 (1998) 5183–5198.
- [4] J. Fröhlich, C. King, The Chern Simons theory and knot polynomials, *Commun. Math. Phys.* 126 (1989) 167–199.
- [5] A. Ashtekar, C. Rovelli, L. Smolin, Weaving a classical geometry with quantum threads, *Phys. Rev. Lett.* 69 (1992) 237.
- [6] D. Altschuler, L. Freidel, Vassiliev knot invariants and Chern–Simons perturbation theory to all orders, *Commun. Math. Phys.* 187 (1997) 261–287.
- [7] R. Bott, C. Taubes, On the self-linking of knots, *J. Math. Phys.* 35 (1994) 5247–5287.
- [8] P. Cartier, Construction combinatoire des invariants de Vassiliev–Kontsevich des noeuds, *C.R. Acad. Sci. Paris, Ser. I* 316 (1993) 1205–1210.
- [9] L.H. Kauffman, New invariants in the theory of knots, *Am. Math. Mon.* 95 (3) (1988) 195–242.
- [10] L.H. Kauffman, P. Vogel, Link polynomials and a graphical calculus, *J. Knot Theory Ramifications* 1 (1) (1992) 59–104.

- [11] V. Vassiliev, Cohomology of knot spaces, in: V.I. Arnold (Ed.), *Theory of Singularities and Its Applications*, American Mathematical Society, Providence, RI, 1990, pp. 23–69.
- [12] J. Birman, X.S. Lin, Knot polynomials and Vassiliev's invariants, *Invent. Math.* 111 (2) (1993) 225–270.
- [13] D. Bar-Natan, On the Vassiliev knot invariants, *Topology* 34 (1995) 423–472.
- [14] E. Witten, Quantum field theory and the Jones polynomial, *Commun. Math. Phys.* 121 (1989) 351–399.
- [15] M.F. Atiyah, *Geometry of Yang–Mills Fields*, Accademia Nazionale dei Lincei Scuola Superiore Lezioni Fermiare, Pisa, 1979.
- [16] N.Y. Reshetikhin, V. Turaev, Invariants of three manifolds via link polynomials and quantum groups, *Invent. Math.* 103 (1991) 547–597.
- [17] V.G. Turaev, H. Wenzl, Quantum invariants of 3-manifolds associated with classical simple Lie algebras, *Int. J. Math.* 4 (2) (1993) 323–358.
- [18] R. Kirby, P. Melvin, On the 3-manifold invariants of Reshetikhin–Turaev for $sl(2, C)$, *Invent. Math.* 105 (1991) 473–545.
- [19] W.B.R. Lickorish, The Temperley Lieb algebra and 3-manifold invariants, *J. Knot Theory Ramifications* 2 (1993) 171–194.
- [20] K. Walker, On Witten's 3-manifold invariants, preprint, 1991.
- [21] L.H. Kauffman, S.L. Lins, *Temperley–Lieb Recoupling Theory and Invariants of 3-Manifolds*, *Annals of Mathematics Study*, Vol. 114, Princeton University Press, Princeton, NJ, 1994.
- [22] M.F. Atiyah, *The Geometry and Physics of Knots*, Cambridge University Press, Cambridge, 1990.
- [23] S. Garoufalidis, Applications of TQFT to invariants in low dimensional topology, preprint, 1993.
- [24] D.S. Freed, R.E. Gompf, Computer calculation of Witten's three-manifold invariant, *Commun. Math. Phys.* (141) (1991) 79–117.
- [25] L.C. Jeffrey, Chern–Simons–Witten invariants of lens spaces and torus bundles, and the semi-classical approximation, *Commun. Math. Phys.* (147) (1992) 563–604.
- [26] L. Rozansky, Witten's invariant of 3-dimensional manifolds: loop expansion and surgery calculus, in: L. Kauffman, (Ed.), *Knots and Applications*, World Scientific, Singapore, 1995.
- [27] D. Adams, The semiclassical approximation for the Chern–Simons partition function, *Phys. Lett. B* 417 (1998) 53–60.
- [28] L. Smolin, Link polynomials and critical points of the Chern–Simons path integrals, *Mod. Phys. Lett. A* 4 (12) (1989) 1091–1112.
- [29] P. Cotta–Ramusino, E. Guadagnini, M. Martellini, M. Mintchev, Quantum field theory and link invariants, *Nucl. Phys. B* 330 (2-3) (1990) 557–574.
- [30] L.H. Kauffman, *Knots and Physics*, World Scientific, Singapore, 1991, 1993.
- [31] S. Albevario, A. Sen–Gupta, A mathematical construction of the non-Abelian Chern–Simons functional integral, *Commun. Math. Phys.* 186 (1997) 563–579.
- [32] A. Robinson, *Non-Standard Analysis*, Princeton University Press, Princeton, NJ, 1996, 1965.
- [33] J.M. Henle, E.W. Kleinberg, *Infinitesimal Calculus*, MIT Press, Cambridge, MA, 1980.
- [34] J.H. Conway, *On Numbers and Games*, Academic Press, New York, 1976.
- [35] J.L. Bell, *A Primer of Infinitesimal Calculus*, Cambridge University Press, Cambridge, 1998.
- [36] S. MacLane, L. Moerdijk, *Sheaves in Geometry and Logic*, Springer, Berlin, 1992.
- [37] E. Guadagnini, M. Martellini, M. Mintchev, Chern–Simons model and new relations between the Homfly coefficients, *Phys. Lett. B* 238 (4) (1989) 489–494.
- [38] V.F.R. Jones, A polynomial invariant of links via von Neumann algebras, *Bull. Amer. Math. Soc.* (129) (1985) 103–112.
- [39] V.F.R. Jones, Hecke algebra representations of braid groups and link polynomials, *Ann. Math.* 126 (1987) 335–338.
- [40] V.F.R. Jones, On knot invariants related to some statistical mechanics models, *Pacific J. Math.* 137 (2) (1989) 311–334.
- [41] L.H. Kauffman, *On Knots*, *Annals Study*, Vol. 115, Princeton University Press, Princeton, NJ, 1987.
- [42] L.H. Kauffman, State models and the Jones polynomial, *Topology* 26 (1987) 395–407.
- [43] L.H. Kauffman, Statistical mechanics and the Jones polynomial, *AMS Contemp. Math. Ser.* 78 (1989) 263–297.
- [44] L.H. Kauffman, Functional integration and the theory of knots, *J. Math. Phys.* 36 (5) (1995) 2402–2429.
- [45] R. Kirby, A calculus for framed links in S^3 , *Invent. Math.* 45 (1978) 35–56.
- [46] M. Kontsevich, *Graphs, homotopical algebra and low dimensional topology*, preprint, 1992.

- [47] T. Kohno, Linear Representations of Braid Groups and Classical Yang-Baxter Equations, Contemporary Mathematics, Vol. 78, Amer. Math. Soc., Providence, RI, 1988, pp. 339–364.
- [48] T.Q.T. Le, J. Murakami, Universal finite type invariants of 3-manifolds, preprint, 1995.
- [49] R. Lawrence, Asymptotic expansions of Witten–Reshetikhin–Turaev invariants for some simple 3-manifolds, *J. Math. Phys.* 36 (11) (1995) 6106–6129.
- [50] M. Polyak, O. Viro, Gauss diagram formulas for Vassiliev invariants, *Intl. Math. Res. Notices* 11 (1994) 445–453.
- [51] N.Y. Reshetikhin, Quantized universal enveloping algebras, the Yang-Baxter equation and invariants of links, I and II, LOMI Reprints E-4-87 and E-17-87, Steklov Institute, Leningrad, USSR.
- [52] V.G. Turaev, The Yang-Baxter equations and invariants of links, LOMI preprint E-3-87, Steklov Institute, Leningrad, USSR; *Inventiones Math.* 92 (3) pp. 527–553.
- [53] V.G. Turaev, O.Y. Viro, State sum invariants of 3-manifolds and quantum $6j$ symbols, *Topology* 31 (1992) 865–902.
- [54] J.H. White, Self-linking and the Gauss integral in higher dimensions, *Am. J. Math.* 91 (1969) 693–728.